

# MOVING WINE STORAGE FORWARD

## RESOURCE GUIDE



VINTAGEVIEW®

MOVING WINE STORAGE FORWARD

# WALL SERIES

We developed our hallmark Wall Series line with designers in mind. It started the label-forward wine storage movement in 2001 bringing modern sophistication to the industry.

Our patented wine rack puts the label on display, creating artful collections perfect for any room – residential or commercial – and any sized collection.



## How it Works

### Included Hardware

**A. End Caps**

**B. M4 Toggle Bolts**  
(for drywall installs only)

**C. #8 Wood Screws**  
(Directly into wood surfaces  
or drywall anchors)

**D. Mounting Hole Covers**

**E. Zinc spiral inserts**  
(for drywall installs only)

**F. Couplers**

(for connecting two Wall Series  
columns vertically)

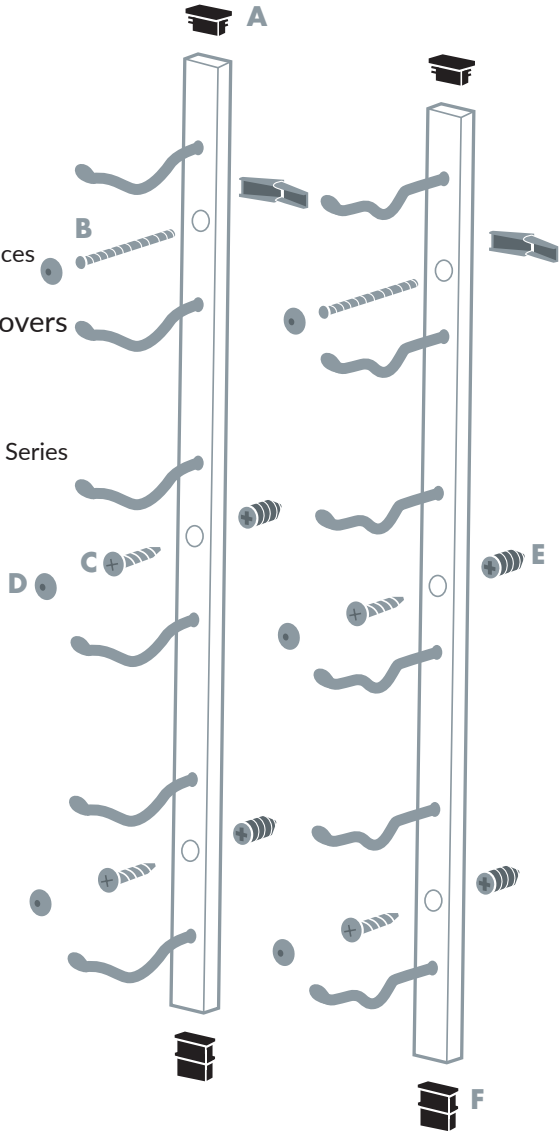

Installation  
Centerline

Standard/Champagne: 7½"  
Magnum: 8½"  
Larger formats: 10"-14" formats

# WALL SERIES

## Specs



### Single

h: 5"  
w: 13"  
d: 5¼"  
capacity: 1



### Minimal

(single-bottle depth)  
h: 1', 2', 3', 4'  
w: 13"  
d: 5¼"  
capacity: 3-12



### Balanced

(double-bottle depth)  
h: 1', 2', 3', 4'  
w: 13"  
d: 8½"  
capacity: 6-24

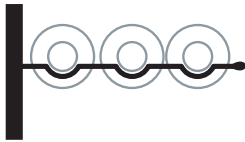

### Maximum

(triple-bottle depth)  
h: 1', 2', 3', 4'  
w: 13"  
d: 12"  
capacity: 9-36



### Magnum Minimal

(single-bottle depth)  
h: 45"  
w: 15"  
d: 5¼"  
capacity: 9

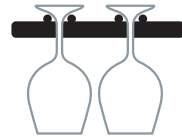

### Stemware Racks

h: 4"  
w: 13"  
d: 6½" | 9.5" | 13"  
glasses: 2 | 4 | 6



### Magnum Balanced

(double-bottle depth)  
h: 45"  
w: 15"  
d: 10"  
capacity: 18



### Big Bottle ≤6L

(single-bottle depth)  
h: 45"  
w: 18"+  
d: 8"  
capacity: 4 (3L-6L)



### Presentation Rows

h: 6"  
w: 13" | 39"  
d: 13"  
capacity: 3 | 9

Specs include room for your wine bottles | These products are subject to one or more US patents.

## Finishes



**Brushed Nickel**  
(-P)



**Chrome**  
(-CH)



**Satin Black**  
(-K)

Ask about custom powder coating!

# WALL SERIES

## Accessories



Stemware Rack



Single



Bottle Retention Strap



Presentation Row



FCF Perch

# FCF MOUNTS

**Floor to Ceiling Frames** create floating wine walls in homes and restaurants, allowing designers to create unique, stylish room dividers.

Simply, FCFs are the utility tool that takes the Wall Series off the wall, allowing for installation even when wall-mounting space is at a premium.



## How it works



The 10-foot frame (two, 5-foot sections) can be cut on site to fit your ceiling height.



Add Wall Series racking to one or both sides.

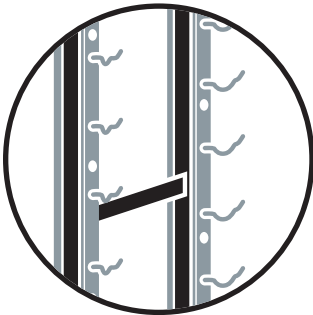
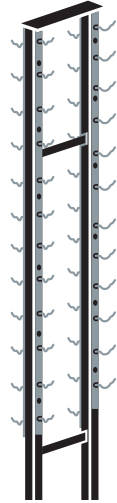

Add a backer bar to one-sided displays.

*Available in 12-foot sections (in stock)  
& 15-foot solid sections (lead times apply)*

### Hardware

Self-drilling metal screws included to mount Wall Series products (racking sold separately).

*Mounting hardware for floor or ceiling not included.*

Installation  
Centerline

Standard/Champagne: 13"  
Magnum: 15"



# FCF MOUNTS

## Specs

### FCF Split

Height	Width	Depth
120 in	Custom	Varies*

### FCF HD

Height	Width	Depth
120 in	13 in	Varies*

### FCF-C12

Height	Width	Depth
144 in	13 in	Varies*

### FCF Mag

Height	Width	Depth
120 in	15 in	Varies*

### FCF Big Bottle

Height	Width	Depth
120 in	Custom	Varies*

## \*Depth (Standard)

Single-Sided Display Depth:

**Single:** 6¾"

**Double:** 10"

**Triple:** 13½"

Double-Sided Display Depth:

**Single, Single:** 11½"

**Single, Double:** 14¾"

**Single, Triple:** 18¼"

**Double, Double:** 18"\*\*\*

**Double, Triple:** 21½"\*\*\*

**Triple, Triple:** 25"\*\*\*

## (Magnum)

Single-Sided Display Depth:

**Single:** 6¾"

**Double:** 11½"

Double-Sided Display Depth:

**Single, Single:** 11½"\*\*\*

**Single, Double:** 16¼"

**Double, Double:** 21"\*\*\*

## (Big Bottle)

Single-Sided Display Depth:

**Single:** 9½"

Double-Sided Display Depth:

**Single:** 17"

\*\* These configurations cannot be label forward against glass without room to pull bottles from the side.

## Finishes



**Brushed Nickel**  
(-P)



**Chrome**  
(-CH)



**Satin Black**  
(-K)

# FCF MOUNTS

## Accessories



Floor-to-Wall Bracket

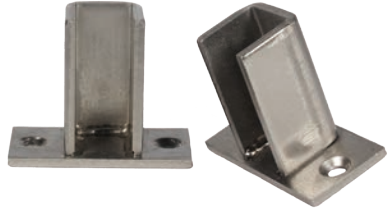

Hidden Base Plate



Extension Bracket



Elbow Bracket



Angled Base Plate



Base Plate (for sections less than 5 feet in height)



FCF Perch

# VINO SERIES

The Vino Series peg system brings a new edge to minimalism in the wine cellar. Starting at just one bottle, the label-forward Pins and cork-forward Rails allow designers to break from linear wine racking and create eye-catching focal points in any room.

Plus, this is the only peg system that can mount directly into any surface, including drywall.



## How it works

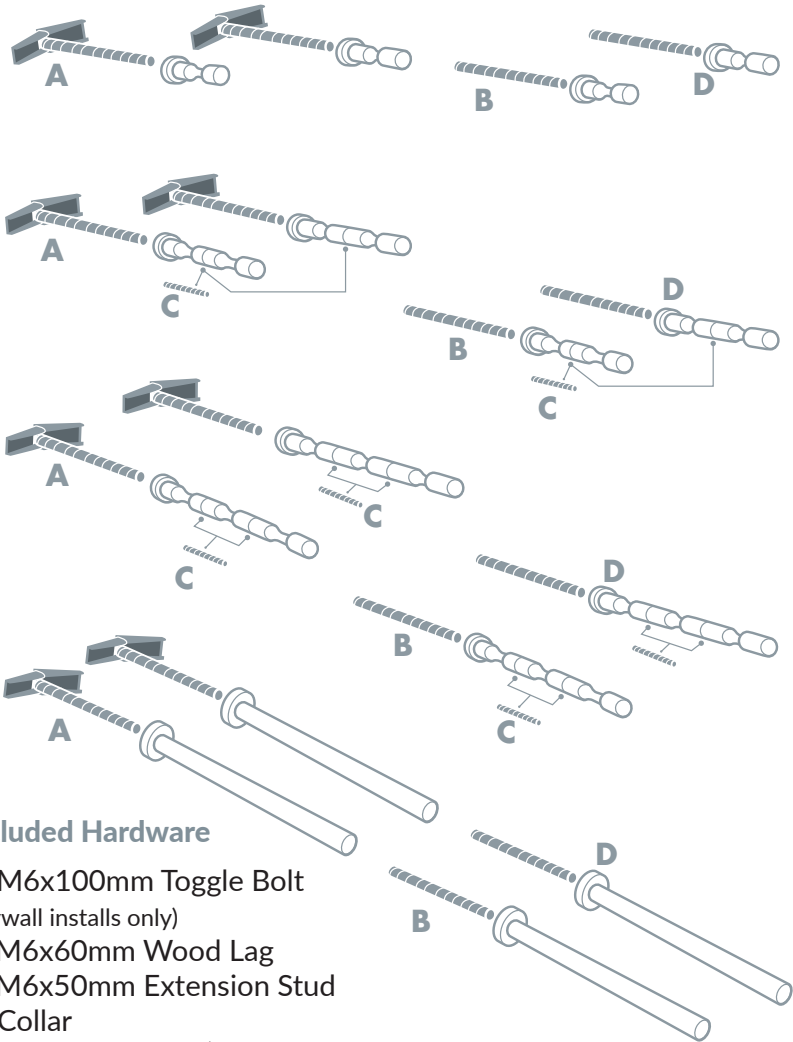

## Included Hardware

- A.** M6x100mm Toggle Bolt  
(drywall installs only)
- B.** M6x60mm Wood Lag
- C.** M6x50mm Extension Stud
- D.** Collar  
(for drywall installs only)

Installation  
Centerline

Pins Standard/Champagne: 7½"  
Pins Magnum: 8½"  
Rails: 2½" (2" for stemware storage)

# VINO SERIES

## Specs



### Minimal

Standard or Mag bottles  
(single-bottle depth)

h: 5"

w: 13" standard/

15" mag

d: 4"\*

capacity: 1



### Balanced

(double-bottle depth)

h: 5"

w: 13"

d: 8"\*

capacity: 2



### Maximum

(triple-bottle depth)

h: 5"

w: 13"

d: 12"\*

capacity: 3

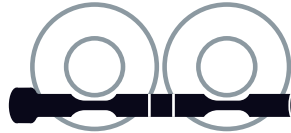

### Magnum Balanced

(double-bottle depth)

h: 5"

w: 15"

d: 8½"\*

capacity: 2 (1.5L)



### Standard Bottle

(single-bottle depth)

h: 5"

w: 3"

d: 13"\*

capacity: 1



### Magnum Bottle

(single-bottle depth)

h: 5"

w: 3"

d: 15"\*

capacity: 1

\* Collars add 1/2" to the depth  
(required for drywall installs)

## Finishes



**Clear Acrylic\***  
(-A)

\*single deep  
pins only



**Milled Aluminum**



**Anodized Black**  
(-K)

Ask about Gunmetal  
and Golden Bronze  
finish options



# VINO SERIES

## Accessories



**Collars**

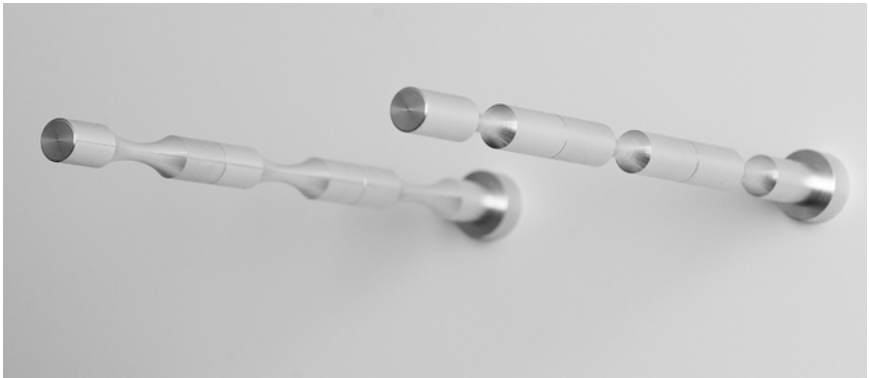

**Extension Pieces**  
(up to three total bottles deep)



**Masonry hardware**



**Magnum spacers**



# CASE & CRATE



**With design and expandability in mind,** the Case & Crate collection brings style to bulk wine storage.

The lockers and bins in this lineup can store bottles by the case load and integrate perfectly with label-forward wine racking displays.

# CASE & CRATE

## How it Works

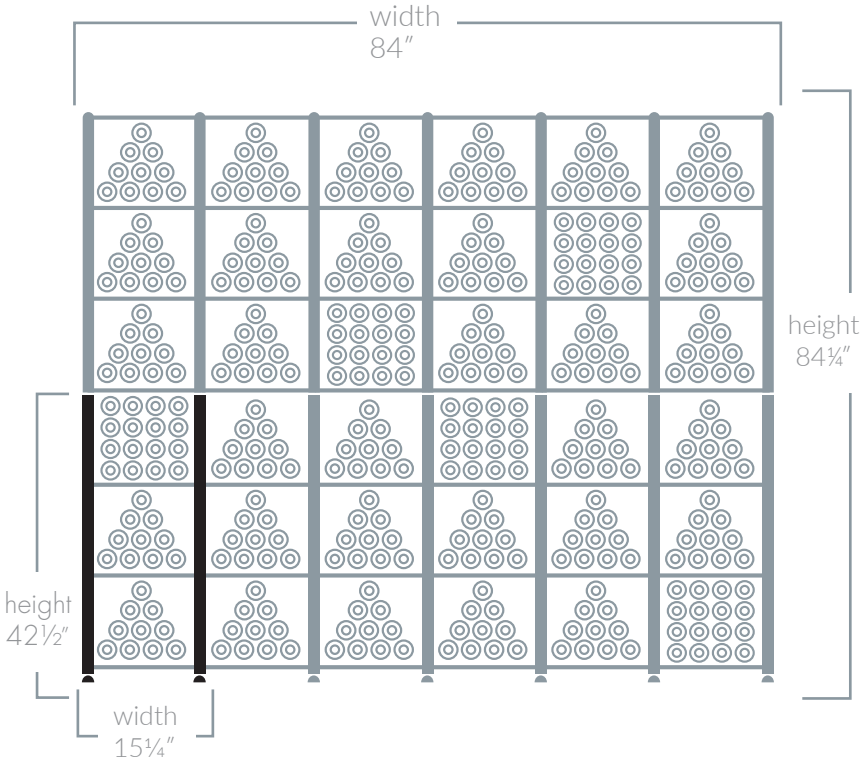

Start with a base unit, stack one on top, and expand to the side as many times as you need with Extension Units!

## Specs

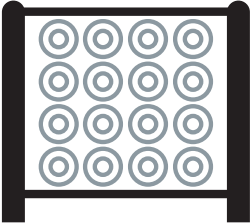

### Bin

h: 42½" | 3 cubes

w: 15¼"

d: 14⅜ "

capacity: 48

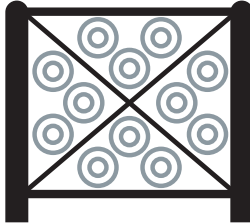

### Bin with X-bins

(optional accessory)

h: 42½" | 3 cubes

w: 15¼"

d: 14⅜ "

capacity: 36

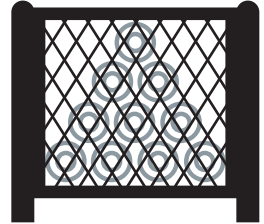

### Locker

h: 42½" | 3 cubes

w: 15¼"

d: 14⅜ "

capacity: 48

*Add 41¾" when stacking*

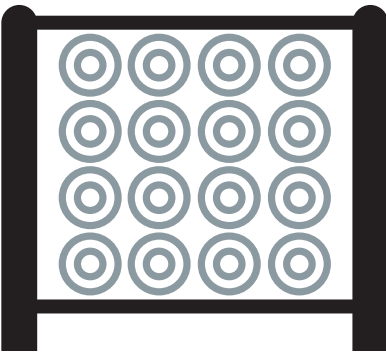

### Included Hardware

Metal screws

Wall bracket

M4 toggle bolt

Adjustable footers

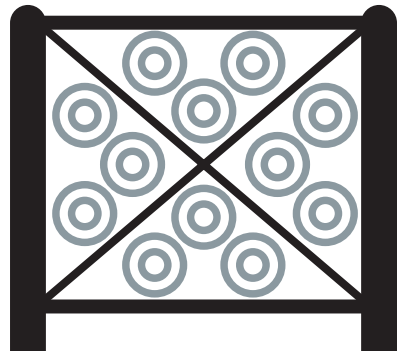

### Bin with X-bin

Reduces count by 4 bottles per cube

# CASE & CRATE

## Finish



**Satin Black**  
(-K)

## Accessories



**CC-Shelf**  
Syrah Shelf



**CC-Back**  
Back Insert



**CC-Xbin**  
X-Bin Insert



**CC-Door**  
Locker Doors



**CC-Lock**  
Locks



**CC-Label**  
Two Styles

# IDR SERIES

We make retail stylish. The Island Display Rack takes the best of our label-forward design, building it into great looking, freestanding wine displays. Customers will love how easy it is to shop their favorite labels.



## How it Works

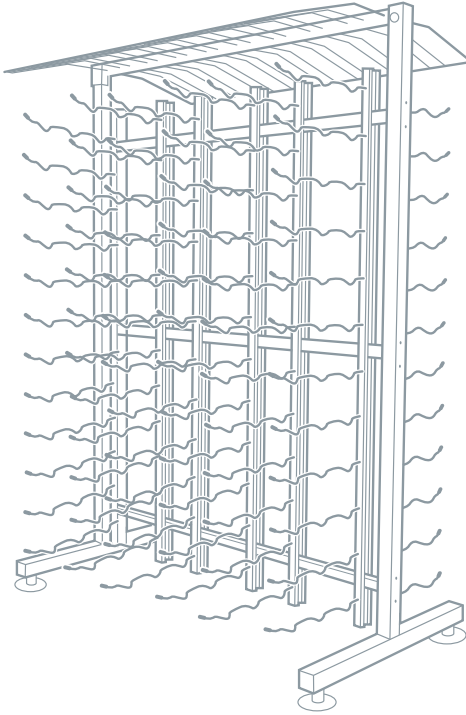

**Included Hardware**  
Everything  
you need to  
assemble!

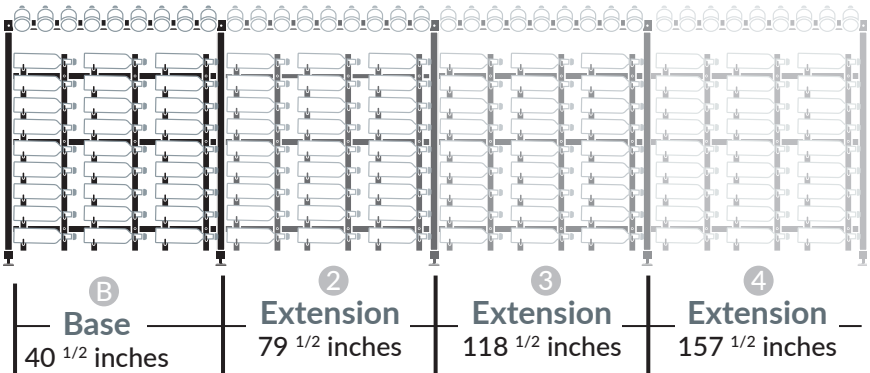

Share an upright! Start with a base unit, and expand to the side as many times as you need with Extension Units!

# IDR SERIES

## Specs

### IDR 3 Kits

	Height	Width	Depth	Columns	Bottles
B	44 <sup>3/4</sup> in	40 <sup>1/2</sup> in	26 <sup>3/4</sup> in	3	180
2	44 <sup>3/4</sup> in	79 <sup>1/2</sup> in	26 <sup>3/4</sup> in	6	360
3	44 <sup>3/4</sup> in	118 <sup>1/2</sup> in	26 <sup>3/4</sup> in	9	540
4	44 <sup>3/4</sup> in	157 <sup>1/2</sup> in	26 <sup>3/4</sup> in	12	720

### IDR 4 Kits

	Height	Width	Depth	Columns	Bottles
B	56 in	40 <sup>1/2</sup> in	26 <sup>3/4</sup> in	3	234
2	56 in	79 <sup>1/2</sup> in	26 <sup>3/4</sup> in	6	468
3	56 in	118 <sup>1/2</sup> in	26 <sup>3/4</sup> in	9	702
4	56 in	157 <sup>1/2</sup> in	26 <sup>3/4</sup> in	12	936

### IDR 7 Kits

	Height	Width	Depth	Columns	Bottles
B	86 <sup>3/4</sup> in	40 <sup>1/2</sup> in	26 <sup>3/4</sup> in	3	288
2	86 <sup>3/4</sup> in	79 <sup>1/2</sup> in	26 <sup>3/4</sup> in	6	576
3	86 <sup>3/4</sup> in	118 <sup>1/2</sup> in	26 <sup>3/4</sup> in	9	864
4	86 <sup>3/4</sup> in	157 <sup>1/2</sup> in	26 <sup>3/4</sup> in	12	1152

### IDR 73 Kits

	Height	Width	Depth	Columns	Bottles
B	87 <sup>1/4</sup> in	40 <sup>1/2</sup> in	24 <sup>1/2</sup> in	3	378
2	87 <sup>1/4</sup> in	79 <sup>1/2</sup> in	24 <sup>1/2</sup> in	6	756
3	87 <sup>1/4</sup> in	118 <sup>1/2</sup> in	24 <sup>1/2</sup> in	9	1134
4	87 <sup>1/4</sup> in	157 <sup>1/2</sup> in	24 <sup>1/2</sup> in	12	1512

## Finishes



**Brushed Nickel**  
(-P)



**Satin Black**  
(-K)



# IDR SERIES

## Accessories



Casters



Shelf Brackets



Price Tag holders



Point of Purchase



End Cap

# EVOLUTION WINE TOWER

The hyper modern Evolution Series Wine Tower continues our legacy of creating contemporary ways to display wine collections, label-forward.



## How it Works

**Included Hardware** Everything you need to assemble! Add an Evolution Series Wall Bracket for added support.

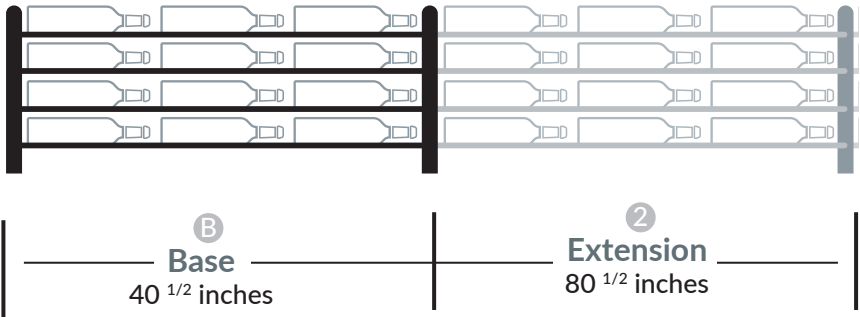

Share an acrylic panel! Start with a base unit, and expand to the side as many times as you need with Extension Units! The Evolution Series Studs connect Wine Rods through shared acrylic walls.

### Or...

Order Evolution Series Wine Rods and hardware to create custom wine displays in millwork, metal, or any other material that can hold the weight of wine. Studs connect Wine Rods through shared common walls.

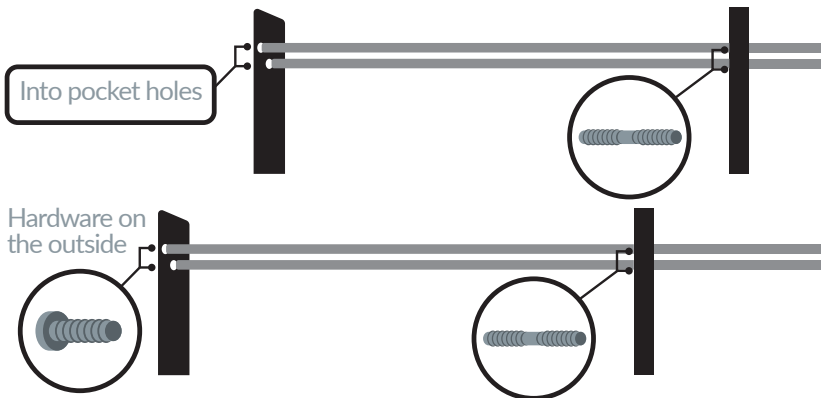

# EVOLUTION WINE TOWER

## Specs

### Wine Tower 4

	Height	Width	Depth	Columns	Bottles
B	47 in	40 <sup>1/2</sup> in	13 <sup>1/2</sup> in	3	81
2	47 in	80 <sup>1/2</sup> in	13 <sup>1/2</sup> in	6	162
3	47 in	120 <sup>1/2</sup> in	13 <sup>1/2</sup> in	9	243
4	47 in	160 <sup>1/2</sup> in	13 <sup>1/2</sup> in	12	364

### Wine Tower 6

	Height	Width	Depth	Columns	Bottles
B	72 in	40 <sup>1/2</sup> in	13 <sup>1/2</sup> in	3	126
2	72 in	80 <sup>1/2</sup> in	13 <sup>1/2</sup> in	6	252
3	72 in	120 <sup>1/2</sup> in	13 <sup>1/2</sup> in	9	378
4	72 in	160 <sup>1/2</sup> in	13 <sup>1/2</sup> in	12	504

### Wine Tower 8

	Height	Width	Depth	Columns	Bottles
B	92 in	40 <sup>1/2</sup> in	13 <sup>1/2</sup> in	3	162
2	92 in	80 <sup>1/2</sup> in	13 <sup>1/2</sup> in	6	324
3	92 in	120 <sup>1/2</sup> in	13 <sup>1/2</sup> in	9	506
4	92 in	160 <sup>1/2</sup> in	13 <sup>1/2</sup> in	12	648

## Finishes



Satin Black Finish



Chrome Finish

# WINE WALL



The **Wine Wall** provides a unique approach to label-forward, wall-mounted storage, offering more spacing between racks to showcase beautiful wall treatments behind the racking.

Plus it stores standard, Champagne, and magnum bottles on the same rack!

# EVOLUTION WINE WALL

## Specs

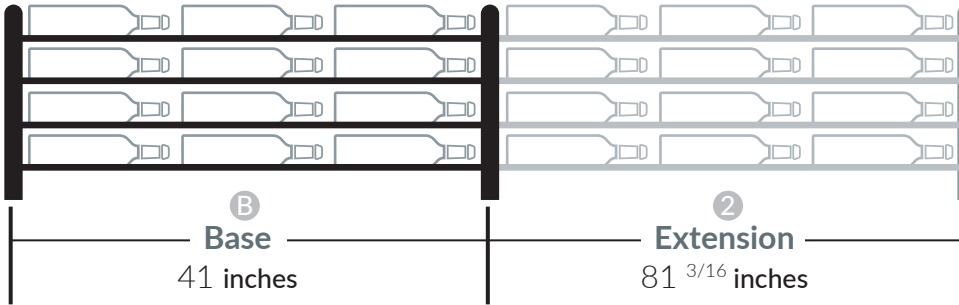

### Wine Wall 5"

Height	Width	Depth	Columns	Bottles
B 5 in	41 in	Varies*	3	3, 6, 9,
2 5 in	81 <sup>3/16</sup> in	Varies*	6	6, 12, 18
3 5 in	121 <sup>3/8</sup> in	Varies*	9	9, 18, 27
4 5 in	161 <sup>9/16</sup> in	Varies*	12	12, 24, 36

### Wine Wall 15"

Height	Width	Depth	Columns	Bottles
B 15 in	41 in	Varies*	3	9, 18, 27
2 15 in	81 <sup>3/16</sup> in	Varies*	6	18, 36, 54
3 15 in	121 <sup>3/8</sup> in	Varies*	9	27, 54, 81
4 15 in	161 <sup>9/16</sup> in	Varies*	12	36, 72, 108

### \*Depths

Single bottle: 4 <sup>1</sup>/<sub>8</sub>" | Double: 8 <sup>1</sup>/<sub>8</sub>" | Triple: 12 <sup>1</sup>/<sub>8</sub>"

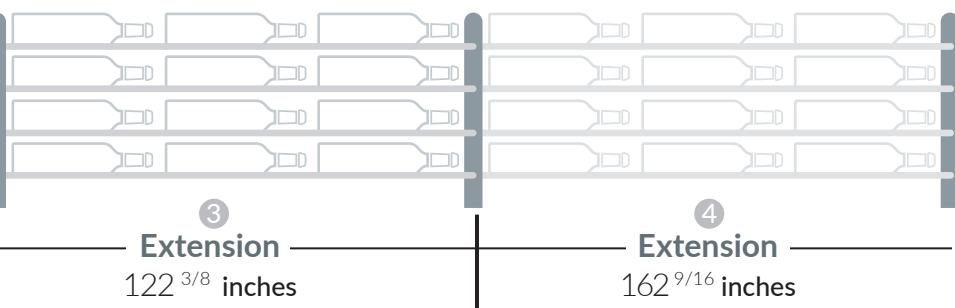

### Wine Wall 30"

Height	Width	Depth	Columns	Bottles
B 30 in	41 in	Varies*	3	18, 36, 54
2 30 in	81 <sup>3/16</sup> in	Varies*	6	36, 72, 108
3 30 in	121 <sup>3/8</sup> in	Varies*	9	54, 108, 162
4 30 in	161 <sup>9/16</sup> in	Varies*	12	72, 144, 216

### Wine Wall 45"

Height	Width	Depth	Columns	Bottles
B 45 in	41 in	Varies*	3	27, 54, 81
2 45 in	81 <sup>3/16</sup> in	Varies*	6	54, 108, 162
3 45 in	121 <sup>3/8</sup> in	Varies*	9	81, 162, 243
4 45 in	161 <sup>9/16</sup> in	Varies*	12	108, 216, 324

### Wine Wall PR

Height	Width	Depth	Columns	Bottles
B 13 <sup>1</sup> / <sub>4</sub> in	41 in	13 <sup>1</sup> / <sub>4</sub> in	3	9
2 13 <sup>1</sup> / <sub>4</sub> in	81 <sup>3</sup> / <sub>16</sub> in	13 <sup>1</sup> / <sub>4</sub> in	6	18
3 13 <sup>1</sup> / <sub>4</sub> in	121 <sup>3</sup> / <sub>8</sub> in	13 <sup>1</sup> / <sub>4</sub> in	9	27
4 13 <sup>1</sup> / <sub>4</sub> in	161 <sup>9</sup> / <sub>16</sub> in	13 <sup>1</sup> / <sub>4</sub> in	12	36

# CUSTOM

The Evolution Series offers a variety of custom options.

**Wine Tower** acrylic panels can come in a variety of depths, heights, widths, and layouts. Wine Wall and Wine Rods can be cut to any width!

**Largest panel available:** 119" tall (23 bottles) by 47" deep (~11 bottles).

**Drill patterns and Bottle Layouts:** Configure to almost any bottle layout

**Width:** Cut any Wine Rod down from 1 meter.

**Design turnaround:** 7-10 business days (some semi custom requests may be quicker)

**Delivery:** 4 to 6 week lead time on project delivery after approval.

